

COUNTERTOP GAS CHARBROILERS

Model	Product ID	Burners
KCBR36	919579	3

STANDARD FEATURES

- High performance & efficient 35,000 BTU stainless steel U style burners provide flame every 6" on charbroiler grates
- Stainless steel front & sides
- Heavy duty 10 gauge stainless steel radiants for consistent heat distribution & non-clog burner protection
- Heavy duty cast iron cooking grates w/ (3) height positions, reversible to offer thick or thin char-marks
- 4" high backsplash & sidesplash protection against grease splatters
- Front-access pilots
- Extended cool to touch front edge
- Removable, easy to clean full width stainless grease catch pan
- All grates & radiants are removable for easy cleaning
- Large chrome knobs
- Adjustable non-skid stainless steel legs

WARRANTY

Kintera Gas Cooking Equipment is warranted to be free from defects in material and workmanship under normal use and service for a period of 1 year from the date of original purchase.



KCBR36
Gas Regulator Included

SPECIFICATIONS

The Kintera Gas Charbroiler radiates heat with efficient 12" U shaped burners that offer a high broiler flame every 6". This gives you flexibility and consistent heat distribution. Temperature controls every 12" allowing you to cook larger or leaner pieces of meat like briskets, pork shoulders and ribs at low heat or crank up the intense heat to cook "Pittsburgh Style" Ribeye, Sirloin or Prime Rib.

Units are shipped for natural gas, but are easily converted to LP (propane) gas with the LP conversion kit that is included.

All Charbroilers carry ETL gas and sanitation approvals that meet US gas and sanitation requirements for use in restaurants.

IMPORTANT INFORMATION

- A pressure regulator is provided with this unit.
Natural Gas 4" (102 mm) W.C.
Propane Gas 10" (279 mm) W.C.
- All equipment is supplied for Natural Gas, an LP conversion kit is also provided.
- 3/4" NPT (19mm) rear gas connection.

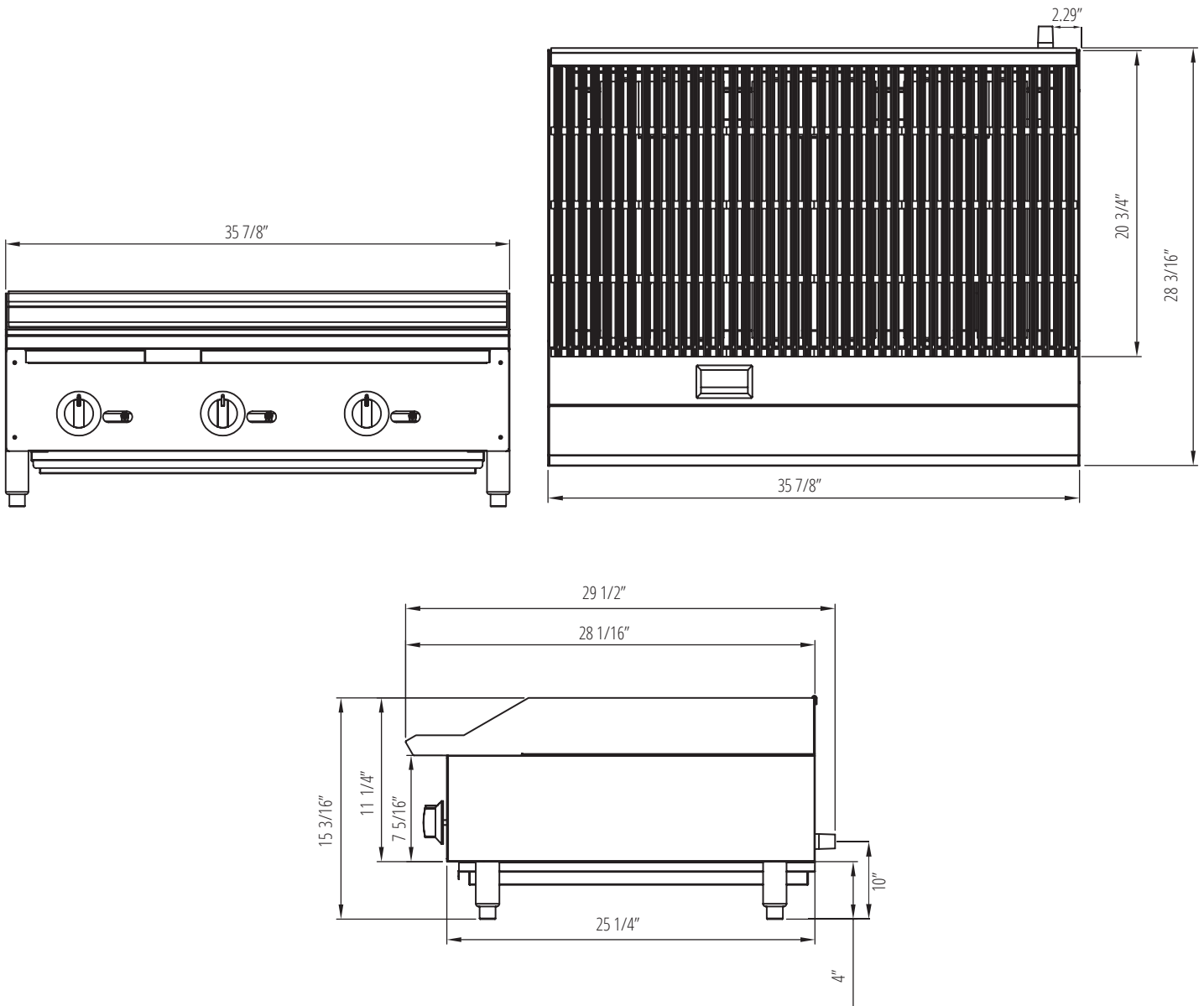

Model	Product ID	Burners	Cooking Area (in)		Controls	Dimensions (in)			BTU's (per burner)	Total BTU's	Crated Weight (lbs)
			D	W		W	D	H			
KCBR36	919579	3	20 3/4	35 7/8	Manual	35 7/8	29 1/2	15 3/16	35,000	105,000	218